

**product warranty**

Inwood Office Environments warrants its products to be free from defects in materials and workmanship given normal use and proper care, for a period of ten (10) years of single shift service.

Specific components are warranted to be free from defects in materials and workmanship for the following periods of time from the date of initial shipment:

<b>electrical components</b>	two (2) years
<b>pneumatic cylinders</b>	three (3) years
<b>control mechanisms</b>	three (3) years
<b>casters</b>	three (3) years

Fabrics will be covered only by the warranty of the original manufacturer.

Inwood tenders this warranty only to original purchasers acquiring our products through those parties specifically authorized by Inwood to sell our products. Repair and/or replacement, at our option, will be made on any part or parts found to be defective within the terms of the warranty. The warranty shall not include any labor or shipping costs for replacement of any such parts or materials.

**This warranty does not cover**

- Damage(s) caused by a transportation company
- Damage(s) resulting from user modification, alterations, misuse, abuse or negligent use of our product
- Damage(s), defect(s), or product failure(s) due to customers request for modifications to product design, product dimensions, product arrangement or normal product specifications
- Natural variations in color, grain, or texture of wood and other covering materials over which Inwood has no control
- Wearing or cuts to covering materials
- Customer's Own Materials (COM)

*Inwood does not make any other warranties except as expressly set forth above, either expressed or implied, including any warranty of merchantability or fitness for any particular purpose. Inwood shall not be liable for consequential or incidental damages under this warranty.*

Further, Inwood makes no warranties, expressed or implied, for improper assembly and/or installation of its products.

**order procedure**

Inwood does not accept orders verbally. Orders may be faxed, e-mailed or mailed directly to:

Inwood Office Environments  
PO Box 646  
Jasper, IN 47546  
Fax: 812.482.9732  
E-mail: inwood@inwood.net

All orders from authorized & credit-approved Inwood Office Environments dealers must be in writing and must include the following information:

- Date
- Purchase Order Number
- Bill to Address
- Ship to Address
- Special Shipping Instructions (delivery notification, special ship dates, ship complete or split shipments, and tags if applicable)
- Complete Model Numbers (include finish & fabric numbers)
- Net Price
- Requested Delivery Date (if applicable)

**order confirmation**

All complete orders will be entered and acknowledged promptly with approximate shipping date(s), transit times, and other pertinent information. This acknowledgement is the final agreement between

Inwood and the customer, superseding all previous communications regarding the order. **NOTE It is the customer's responsibility to check the acknowledgment for accuracy. Please advise Inwood immediately of any discrepancies.**

**changes and cancellations**

Because many of our casegood products and all of our seating products are made to order, we must limit customer changes and cancellations. We regret that changes and cancellations are not possible once production has begun. Production normally begins 48 hours after receipt of order. Orders for standard casegood products with in-stock finishes may be cancelled for a 30% restocking fee. Any non-stock finish is considered made to order and cannot be changed or cancelled.

**delivery information**

Shipments are FOB destination for the 48 contiguous states. Orders are priced by destination zone as listed by state.

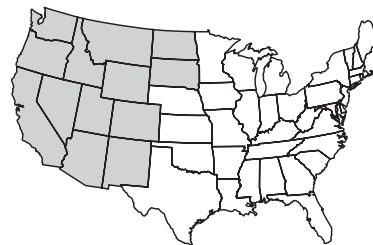

**zone 1** □

Alabama, Arkansas, Connecticut, Delaware, Florida, Georgia, Illinois, Indiana, Iowa, Kansas, Kentucky, Louisiana, Maine, Maryland, Massachusetts, Michigan, Minnesota, Missouri, Nebraska, New Hampshire, New Jersey, New York, North Carolina, Ohio, Oklahoma, Pennsylvania, Rhode Island, South Carolina, Tennessee, Texas, Virginia, West Virginia and Wisconsin.

**zone 2** ■

Arizona, California, Colorado, Idaho, Montana, Nevada, New Mexico, North Dakota, Oregon, South Dakota, Utah, Washington and Wyoming.

Orders of less than 500 lbs will be assessed a handling charge of \$100.00 net per order. Inwood reserves the right to select the most appropriate carrier and routing on all shipments. Any charge arising from failure to receive a shipment, rerouting while in transit or carrier storage charges are not included in prices shown and will be billed to the 'sold to' account on the order.

Any order requiring special delivery services will incur additional charges at the time of invoicing. All such requirements must be noted on the purchase order. These are services that are billed to Inwood by the freight company or require the usage of specialized carriers, and not included in the standard price of the product. Examples of such services include:

- **delivery notification or call ahead requests**  
\$10 Net Charge
- **inside delivery**  
minimum \$100 Net Charge
- **non dock delivery**  
minimum \$100 Net Charge
- **weekend delivery (friday after 4:00pm-sunday night)**  
minimum \$500 Net Charge
- **residential delivery**  
Customer Service may assist you in determining your special delivery requirements and any additional charges that may apply
- **fuel surcharges**  
We will continue to do our best to absorb the increased cost from our transportation vendors; however, if the price

of fuel increases above the normal rates, it may require us to pass on the increased costs. We will address this situation with a fuel surcharge rather than a price increase so that we can eliminate it as appropriate.

Contact Customer Service if you are unsure if your order requires one or more of the above services. We will make every attempt to avoid additional charges by giving options on what we can do within our standard delivery prices.

All prepaid shipments by Inwood Office Environments will be on carriers of our choice. If you choose to order product FOB Factory, please specify the carrier you require. Product will ship Freight Collect and Inwood's responsibility will cease upon delivery to the carrier.

**order postponements and delivery changes**

Changes may be made to delivery address no later than 5 days before the acknowledged ship date of an order. Contact Customer Service for charges which may be incurred for delivery changes within 5 days of the acknowledged ship date. If it becomes necessary to postpone an order after production has begun, the order will be completed, stored and invoiced to the customer with normal terms. Storage fees of \$2.00 per 100 lbs or \$5.00 minimum per day will occur on all orders that are not picked up or released for shipment after 10 working days from the acknowledged ship date.

**claim process for merchandise damage/shortage/carrier delay**

All products produced by Inwood are carefully inspected and properly packed prior to shipment. All shipments are delivered to the transportation company in good condition. If you receive a shipment that has damage, product shortage, or delivery has been delayed by the carrier, the following steps must be taken:

- Before signing for any merchandise, make notation of all visible damage, shortages, and/or time of truck arrival on the freight bill (bill of lading).
- Contact Inwood Customer Service within 15 calendar days of goods receipt to report issue. Legal title to merchandise passes to the buyer upon acceptance by the carrier. We will work with you to file any necessary claims when reported to us within the 15 day time frame.
- Retain all packing materials/cartons for inspection by the carrier agent.

Failure to make any claims against Inwood Office Environments within 15 days shall constitute acceptance of the merchandise and a waiver of any errors or shortages discovered upon inspection.

**repairs and returns**

No repairs or returns will be considered without first obtaining our written permission. Such requests must be made in writing within 15 days of the invoice. Authorization must be obtained from Customer Service prior to repairs being made if Inwood is expected to pay these charges. Charges will be approved only after an estimate has been provided. Credit will be issued only after receipt of repair bills.

Made to order items are not returnable. This includes upholstered seating, special items, special finishes, and any non-stock finish. Authorized returns of stock items will be charged a minimum 30% restocking fee. All returns are subject to an attempted pick-up charge of \$200. Please insure that all goods are packed and tagged correctly before calling Inwood for pick up. All RMA's (Return Materials Authorization) will expire within 30 days of notification. Once expired, a new authorization is required for any return. Upon receipt of returned goods, Inwood will inspect and assess responsibility for any defects. If damage of the merchandise was caused by abuse, alteration, or unauthorized repair, we may offer to repair the merchandise for a fee. The final responsibility for determining damage remains with Inwood.

All merchandise must be shipped freight prepaid or we will not accept. All merchandise being returned must be properly packed and protected to insure that no further damage is incurred during transportation back to Inwood.

**special construction agreement**

When requested that Inwood Office Environments Inc. modify, change or alter its standard product in order to meet the specific needs of Customer, Inwood shall exercise its best efforts to modify its standard product to incorporate the modifications and changes requested by Customer. Inwood Office Environments disclaims any warranty with respect to the modifications or changes requested by Customer and its standard warranty shall not apply to said modifications or changes. Customer shall have no right to rescind its order of this product after production of the product has begun. Customer assumes the risk of the use of Inwood Office Environments product containing the modifications or changes requested by Customer. In no event shall the product containing the modifications or changes requested by Customer be returnable to Inwood Office Environments.

**replacement parts**

Contact Inwood Customer Service for item numbers and pricing on replacement parts.

**dimensions**

All dimensions referenced in this book are nominal.

**terms**

1% 15 days, 30 days net.

Payments are accepted in US Dollars. Payment is also accepted by Visa & Mastercard credit cards, and is posted prior to shipment.

When payment is made with a credit card, no additional discounts may be taken.



Prices are effective with the date printed on this price list and supersede all other prices. Orders are accepted at the price in effect on the date the order is received. Possession of this price list does not constitute an offer to sell. Inwood sells to authorized and approved dealers only. Any or all prices, product, and line art are subject to change without notification. Internet or software packages, which support the sale of Inwood products, furnished to the customer either by Inwood or any other source are superseded by revised price lists.

**minimum order**

\$10 US Dollars list price.

**standard special upcharges**

Inwood Office Environments provides the following standard special modifications to its product. Simply specify the request and add the associated price to list.

to make standard top size shorter or narrower . . . . .	<b>\$248</b>
to change file drawer pedestal in desks, credenzas and modular cabinets to box drawers . . . . .	<b>\$218</b>
to change 2 box drawers in desk to file drawer . . . . .	<b>\$140</b>
to change position of file drawer in desks . . . . .	<b>\$106</b>
to add locks where not standard	
- box, file drawer or center drawer . . . . .	<b>\$56</b>
- hinged door, single . . . . .	<b>\$56</b>
- hinged door, double . . . . .	<b>\$58</b>
to key items alike from factory per unit . . . . .	<b>\$31</b>
to add extra lock per set (including set of keys) . . . . .	<b>\$21</b>
extra set of keys (two) . . . . .	<b>\$21</b>
to add grommets in any special location . . . . .	<b>\$128</b>
to move standard placement of grommet on unit . . . . .	<b>\$56</b>
grommets (cover only) . . . . .	<b>\$21</b>
to add extra shelf for bookcase . . . . .	<b>\$77</b>
to make shelves solid wood (per shelf) . . . . .	<b>\$23</b>
for typing height return . . . . .	<b>\$197</b>
for non-standard Inwood pulls	
(to change to another series per unit) . . . . .	<b>\$71</b>
special finishes (6 item minimum)	
- non-Inwood finishes . . . . .	<b>20%</b>
- standard Inwood finishes . . . . .	<b>15%</b>

dlh pointman

wood top, veneer chassis, veneer drawer fronts  
laminated top, veneer chassis, veneer drawer fronts



**dlh pointman series specifications**

**materials:**

All wood is thoroughly air and kiln dried to a moisture content not to exceed 8% at the time of assembly.

**veneers:**

All exposed surfaces are plain sliced Cherry, American Black Walnut or White Maple Veneer. Walnut veneers are carefully book-matched. Cherry and Maple veneers are slip-matched. All drawer fronts, doors, end panels, and modesty panels are vertical grain.

**top work surfaces:**

Laminate tops are 1 1/4" thick, 3-ply construction; consisting of a high-pressure laminate work surface and a 45 lb density flake board core. The under side of the top has a smooth surface Gator-Ply backing sheet. Top rims are 3/4" hardwood with a choice of top edge shape on all four sides.

**modesty panels:**

3/4" thick, 3-ply construction with a vertical book matched veneer on exposed surfaces and a 45 lb density flake board core. Desk modesty panels are full to the floor.

**construction:**

Uses a mortise & tenon and glue to join panels and modesty panels. All joints are reinforced with glue blocks. Each desk pedestal has an easy slide out dictation arm/mousing slide mounted above the drawers for more work surface area. All pedestals have a side route finger drawer pulls.

**drawers:**

Drawer fronts are 3/4" thick, 3-ply construction with vertical book matched veneer. Drawer edges are veneered on top and sides with matching wood veneers. All drawer sides and backs are plywood, dovetailed front and back with 3-ply drawer bottoms. Drawer bottoms are framed on four sides and stapled from the bottom side. Drawer interiors are finished with a clear coat sealer to prevent swelling or shrinkage. Box drawers have a high grade Sterling metal ball-bearing drawer suspension. File drawers have a high grade Sterling metal ball bearing full progressive suspension and are equipped with metal rods for hanging file folders. All drawers have smooth quiet operation.

**locking:**

Each pedestal has its own lock and is keyed alike for each unit. Each unit is equipped with two keys. Units may be keyed alike in groups (per office, if requested) for an additional charge of \$31 per unit.

**finish:**

All Inwood finishes are catalyzed varnish and have excellent durability. Our multi-step satin finishes leave a beautiful natural look to the furniture, and are available in the following finishes: (3L) walnut, (2KL) walnut, (25M) mahogany, (4L) dark mahogany, (25C) cherry, (2ML) natural maple, (3ML) light maple, (4ML) medium maple, (5ML) cherry finish on maple, (6LC) Light Cherry, (7MC) Medium Cherry, (8DC) Dark Cherry.

**dlh pointman lift system:**

The lift system is driven by two linear actuators, which have 180 lbs of thrust each. These are powered by a 120 volt electric control box which supplies a smooth quiet travel at 1.5"/second. The lift system is located in the kneespace area and is secured by a lockable hinged access panel. The control switch is secured inside the CPU pedestal. With the touch of a button, the DLH Pointman Organizer ascends from the unit to reveal the storage compartment. Another touch of a button descends the DLH Pointman back into the unit. The down stroke has an anti-collision function which will stop the descent if there is an obstruction.

**dlh pointman series dimensions**

**36" x 72" desks:**

center bay inside dimensions .....8 1/4"d x 17 1/2"h x 47 5/16"w  
left/right bay area dimensions.....8 1/4"d x 17 1/2"h x 6 1/4"w  
height of unit when fully open.....19 1/2"h  
overall height when fully open .....48 1/2"h

**36" x 66" desks:**

center bay inside dimensions .....8 1/4"d x 17 1/2"h x 41 5/16"w  
left/right bay area dimensions.....8 1/4"d x 17 1/2"h x 6 1/4"w  
height of unit when fully open.....19 1/2"h  
overall height when fully open .....48 1/2"h

**30" x 66" desks:**

center bay inside dimensions .....8 1/4"d x 17 1/2"h x 25 3/4"w  
left/right bay area dimensions.....open  
height of unit when fully open.....19 1/2"h  
overall height when fully open .....48 1/2"h

**72" wide credenzas:**

center bay inside dimensions .....8 1/4"d x 17 1/2"h x 31 3/4"w  
left/right bay area dimensions.....open  
height of unit when fully open.....19 1/2"h  
overall height when fully open .....48 1/2"h

**66" wide credenzas:**

center bay inside dimensions .....8 1/4"d x 17 1/2"h x 25 3/4"w  
left/right bay area dimensions.....open  
height of unit when fully open.....19 1/2"h  
overall height when fully open .....48 1/2"h

**dlh pointman additions**

contact the customs department to inquire about installing the DLH Pointman Organizer in other Inwood units.

	model number	description	d w h	freight	list \$ zone 1	list \$ zone 2
	PDFBT2372RCFP- - - - -	double pedestal bow front desk left box/file pedestal right cpu pedestal	42 72 29  APPROACH: 6" KNEESPACE: 40"	class 125 cwt 455 lb cu ft 55	5,797 W  5,215 P	6,169 W  5,695 P
	PDFBT2372LCFP- - - - -	double pedestal bow front desk left cpu pedestal right box/file pedestal	42 72 29  APPROACH: 6" KNEESPACE: 40"	class 125 cwt 455 lb cu ft 55	5,797 W  5,215 P	6,169 W  5,695 P
	PDF2372RCFP- - - - -	double pedestal desk left box/file pedestal right cpu pedestal	36 72 29  KNEESPACE: 40"	class 125 cwt 450 lb cu ft 53	4,268 W  3,937 P	4,520 W  4,166 P
	PDF2372LCFP- - - - -	double pedestal desk left cpu pedestal right box/file pedestal	36 72 29  KNEESPACE: 40"	class 125 cwt 450 lb cu ft 53	4,268 W  3,937 P	4,520 W  4,166 P
	PDF2366RCFP- - - - -	double pedestal desk left box/file pedestal right cpu pedestal	36 66 29  KNEESPACE: 34"	class 125 cwt 420lb cu ft 48	4,184 W  3,905 P	4,432 W  4,131 P
	PDF2366LCFP- - - - -	double pedestal desk left cpu pedestal right box/file pedestal	36 66 29  KNEESPACE: 34"	class 125 cwt 420lb cu ft 48	4,184 W  3,905 P	4,432 W  4,131 P
	PDF236630RCFP- - - - -	double pedestal desk left box/file pedestal right cpu pedestal	30 66 29  KNEESPACE: 34"	class 125 cwt 405 lb cu ft 40	3,822 W  3,749 P	4,043 W  3,964 P
	PDF236630LCFP- - - - -	double pedestal desk left cpu pedestal right box/file pedestal	30 66 29  KNEESPACE: 34"	class 125 cwt 405 lb cu ft 40	3,822 W  3,749 P	4,043 W  3,964 P
	PCCR237224RCFP - - - -	kneespace credenza left file/file pedestal right cpu pedestal	24 72 29  KNEESPACE: 31.5"	class 125 cwt 355 lb cu ft 34	3,644 W  3,547 P	3,969 W  3,855 P

laminated  
tops only

3L-P walnut  
4L-P dark mahogany on walnut  
25M-P mahogany on walnut  
25C-P cherry on walnut  
25B-P ebony on walnut  
2ML-P natural maple  
3ML-P light maple  
4ML-P medium maple  
5ML-P cherry on maple  
6LC-P light cherry on cherry  
7MC-P medium cherry on cherry  
8DC-P dark cherry on cherry

veneers  
top and  
chassis  
finish

3L-W walnut  
2KL-W walnut  
4L-W dark mahogany on walnut  
25M-W mahogany on walnut  
25B-W ebony on walnut  
25C-W cherry on walnut  
2ML-W natural maple  
3ML-W light maple  
4ML-W medium maple  
5ML-W cherry on maple  
6LC-W light cherry on cherry

7MC-W medium cherry on cherry  
8DC-W dark cherry on cherry  
9BC-W burgundy cherry on cherry

PDFBT2372RCFP-3L-W-A

unit identification (type), top dimension, chassis option - **chassis & top finish - top material - edge trim**

dlh pointman

wood top, veneer chassis, veneer drawer fronts  
laminated top, veneer chassis, veneer drawer fronts



	model number	description	d w h	freight	list \$ zone 1	list \$ zone 2
	PCCR237224LCFP- - - - - PCCR217224LCFP- - - - -	kneespace credenza left file/file pedestal right cpu pedestal	24 72 29 <i>KNEESPACE: 31.5"</i>	class 125 cwt 355 lb cu ft 34	3,644 W 3,547 P	3,969 W 3,855 P
	PCCR236624RCFP- - - - - PCCR216624RCFP- - - - -	kneespace credenza right file/file pedestal left cpu pedestal	24 66 29 <i>KNEESPACE: 25.5"</i>	class 125 cwt 340 lb cu ft 30	3,527 W 3,472 P	3,764 W 3,735 P
	PCCR236624LCFP- - - - - PCCR216624LCFP- - - - -	kneespace credenza left cpu pedestal right file/file pedestal	24 66 29 <i>KNEESPACE: 25.5"</i>	class 125 cwt 340 lb cu ft 30	3,527 W 3,472 P	3,764 W 3,735 P
	PDDBT2372RCFP- - - - - PDDBT2172RCFP- - - - -	bow front single pedestal desk right cpu pedestal	42 72 29 <i>APPROACH: 6"</i>	class 125 cwt 380 lb cu ft 55	5,188 W 4,560 P	5,518 W 4,839 P
	PDDBT2372LCFP- - - - - PDDBT2172LCFP- - - - -	bow front single pedestal desk left cpu pedestal	42 72 29 <i>APPROACH: 6"</i>	class 125 cwt 380 lb cu ft 55	5,188 W 4,560 P	5,518 W 4,839 P
	PDD2372RCFP- - - - - PDD2172RCFP- - - - -	single pedestal desk right cpu pedestal	36 72 29	class 125 cwt 375 lb cu ft 53	3,790 W 3,282 P	4,008 W 3,459 P
	PDD2372LCFP- - - - - PDD2172LCFP- - - - -	single pedestal desk left cpu pedestal	36 72 29	class 125 cwt 375 lb cu ft 53	3,790 W 3,282 P	4,008 W 3,459 P
	PDD2366RCFP- - - - - PDD2166RCFP- - - - -	single pedestal desk right cpu pedestal	36 66 29	class 125 cwt 350 lb cu ft 48	3,635 W 3,258 P	3,838 W 3,433 P
	PDD2366LCFP- - - - - PDD2166LCFP- - - - -	single pedestal desk left cpu pedestal	36 66 29	class 125 cwt 350 lb cu ft 48	3,635 W 3,258 P	3,838 W 3,433 P

	model number	description	d w h	freight	list \$ zone 1	list \$ zone 2
	PDD236630RCFP- - - - - PDD216630RCFP- - - - -	single pedestal desk right cpu pedestal	30 66 29	class 125 cwt 340 lb cu ft 40	3,509 W 2,892 P	3,705 W 3,037 P
	PDD236630LCFP- - - - - PDD216630LCFP- - - - -	single pedestal desk left cpu pedestal	30 66 29	class 125 cwt 340 lb cu ft 40	3,509 W 2,892 P	3,705 W 3,037 P
	PCC2372RCFP- - - - - PCC2172RCFP- - - - -	single pedestal credenza right cpu pedestal	24 72 29	class 125 cwt 150 lb cu ft 28	3,113 W 2,858 P	3,276 W 3,001 P
	PCC2372LCFP- - - - - PCC2172LCFP- - - - -	single pedestal credenza left cpu pedestal	24 72 29	class 125 cwt 150 lb cu ft 28	3,113 W 2,858 P	3,276 W 3,001 P
	PCC2366RCFP- - - - - PCC2166RCFP- - - - -	single pedestal credenza right cpu pedestal	24 66 29	class 125 cwt 150 lb cu ft 26	2,958 W 2,706 P	3,110 W 2,837 P
	PCC2366LCFP- - - - - PCC2166LCFP- - - - -	single pedestal credenza left cpu pedestal	24 66 29	class 125 cwt 150 lb cu ft 26	2,958 W 2,706 P	3,110 W 2,837 P

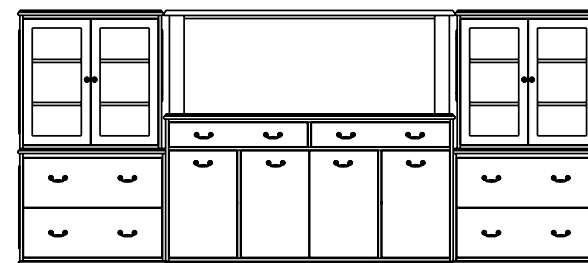

	d	w	h
point unit	24	144	63
pointman unit only	6	61.9	25.9

PLEASE NOTE: PRICE LISTED IS FOR THE POINTMAN UNIT ONLY.

\*SEE PAGE 342 FOR POINT UNIT BREAKDOWN

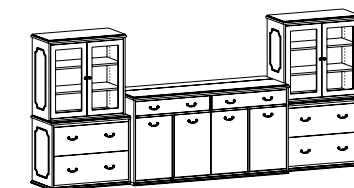

	freight	list \$ zone 1	list \$ zone 2
class 125 cwt 935 lb cu ft 110		12,229 W	13,203 W
		11,392 P	12,300 P

top  
P laminate top  
W veneer top

edge



laminated tops only

- 3L-P walnut
- 4L-P dark mahogany on walnut
- 25M-P mahogany on walnut
- 25C-P cherry on walnut
- 25B-P ebony on walnut
- 2ML-P natural maple
- 3ML-P light maple
- 4ML-P medium maple
- 5ML-P cherry on maple
- 6LC-P light cherry on cherry
- 7MC-P medium cherry on cherry
- 8DC-P dark cherry on cherry

veneered top and chassis finish

- 3L-W walnut
- 2KL-W walnut
- 4L-W dark mahogany on walnut
- 25M-W mahogany on walnut
- 25B-W ebony on walnut
- 25C-W cherry on walnut
- 2ML-W natural maple
- 3ML-W light maple
- 4ML-W medium maple
- 5ML-W cherry on maple
- 6LC-W light cherry on cherry

- 7MC-W medium cherry on cherry
- 8DC-W dark cherry on cherry
- 9BC-W burgundy cherry on cherry

**PDFBT2372RCFP-3L-W-A**

unit identification (type), top dimension, chassis option - **chassis & top finish - top material - edge trim**

model number	description	d	w	h	freight	list \$ zone 1	list \$ zone 2
<b>PDMBT2372RC-EHFP</b>	executive "I" unit	90	72	29	class 125 cwt 555 lb cu ft 76	<b>6,666 W</b>	<b>7,115 W</b>
<b>PDMBT2172RC-EHFP</b>						<b>5,805 P</b>	<b>6,184 P</b>

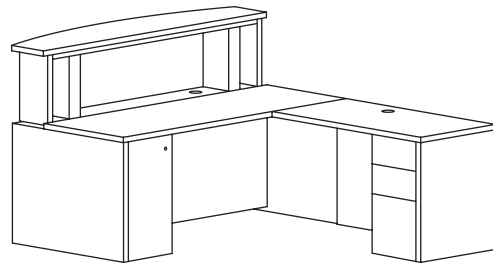

consists of:	d	w	h	quantity
PDDBT2372LFCFP/PDDBT2172LFCFP bow front single pedestal desk left cpu pedestal	42	72	29	1
R2348R-EHFP/R2148R-EHFP single pedestal return right box/box/file pedestal	24	48	29	1

model number	description	d	w	h	freight	list \$ zone 1	list \$ zone 2
<b>PDMBT2372LC-EHFP</b>	executive "I" unit	90	72	29	class 125 cwt 555 lb cu ft 76	<b>6,666 W</b>	<b>7,115 W</b>
<b>PDMBT2172LC-EHFP</b>						<b>5,805 P</b>	<b>6,184 P</b>

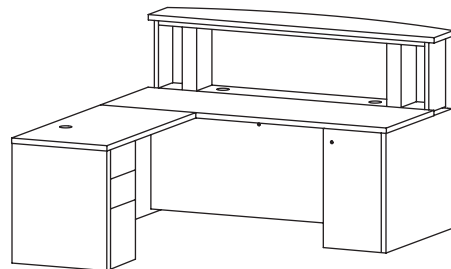

consists of:	d	w	h	quantity
PDDBT2372RCFP/PDDBT2172RCFP bow front single pedestal desk right cpu pedestal	42	72	29	1
R2348L-EHFP/R2148L-EHFP single pedestal return left box/box/file pedestal	24	48	29	1

model number	description	d	w	h	freight	list \$ zone 1	list \$ zone 2
<b>PDM2372RC-EHFP</b>	executive "I" unit	84	72	29	class 125 cwt 550 lb cu ft 74	<b>5,268 W</b>	<b>5,605 W</b>
<b>PDM2172RC-EHFP</b>						<b>4,527 P</b>	<b>4,804 P</b>

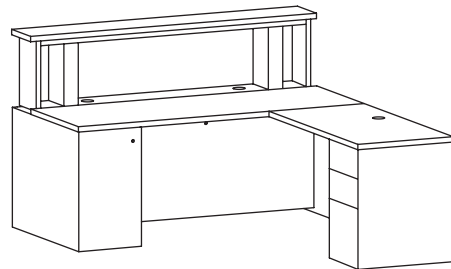

consists of:	d	w	h	quantity
PDD2372LFCFP/PDD2172LFCFP single pedestal desk left cpu pedestal	36	72	29	1
R2348R-EHFP/R2148R-EHFP single pedestal return right box/box/file pedestal	24	48	29	1

**top** **P** laminate top **returns** custom length return sizes are available up to 65" with the grain direction running lengthwise (opposite the desk grain), add \$410 list and specify length.  
**W** veneer top

**edge**



**dlh pointman**

wood top, veneer chassis, veneer drawer fronts  
laminate top, veneer chassis, veneer drawer fronts



model number	description	d	w	h	freight	list \$ zone 1	list \$ zone 2
<b>PDM2372LC-EHFP</b>	executive "I" unit	84	72	29	class 125 cwt 550 lb cu ft 74	<b>5,268 W</b>	<b>5,605 W</b>
<b>PDM2172LC-EHFP</b>						<b>4,527 P</b>	<b>4,804 P</b>

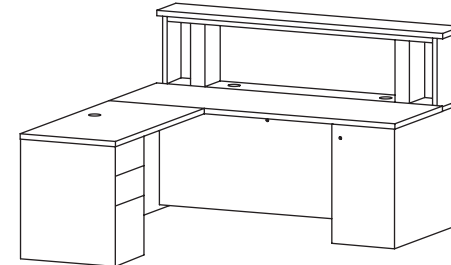

consists of:	d	w	h	quantity
PDD2372RCFP/PDD2172RCFP single pedestal desk right cpu pedestal	36	72	29	1
R2348L-EHFP/R2148L-EHFP single pedestal return left box/box/file pedestal	24	48	29	1

model number	description	d	w	h	freight	list \$ zone 1	list \$ zone 2
<b>PDM2366RC-EHFP</b>	executive "I" unit	84	66	29	class 125 cwt 530 lb cu ft 71	<b>5,113 W</b>	<b>5,435 W</b>
<b>PDM2166RC-EHFP</b>						<b>4,503 P</b>	<b>4,778 P</b>

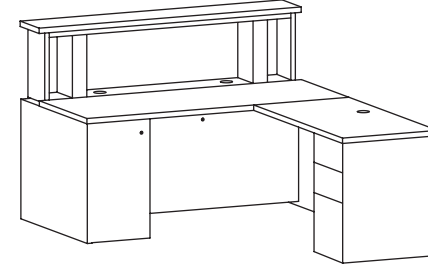

consists of:	d	w	h	quantity
PDD2366LFCFP/PDD2166LFCFP single pedestal desk left cpu pedestal	36	66	29	1
R2348R-EHFP/R2148R-EHFP single pedestal return right box/box/file pedestal	24	48	29	1

model number	description	d	w	h	freight	list \$ zone 1	list \$ zone 2
<b>PDM2366LC-EHFP</b>	executive "I" unit	84	66	29	class 125 cwt 530 lb cu ft 71	<b>5,113 W</b>	<b>5,435 W</b>
<b>PDM2166LC-EHFP</b>						<b>4,503 P</b>	<b>4,778 P</b>

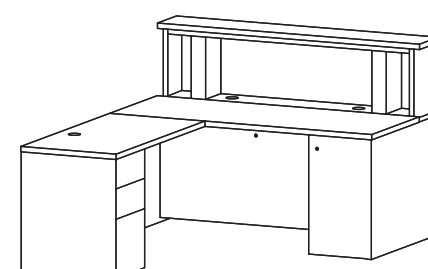

consists of:	d	w	h	quantity
PDD2366RCFP/PDD2166RCFP single pedestal desk right cpu pedestal	36	66	29	1
R2348L-EHFP/R2148L-EHFP single pedestal return left box/box/file pedestal	24	48	29	1

**laminate tops only**  
**3L-P** walnut  
**4L-P** dark mahogany on walnut  
**25M-P** mahogany on walnut  
**25C-P** cherry on walnut  
**25B-P** ebony on walnut  
**2ML-P** natural maple  
**3ML-P** light maple  
**4ML-P** medium maple  
**5ML-P** cherry on maple  
**6LC-P** light cherry on cherry  
**7MC-P** medium cherry on cherry  
**8DC-P** dark cherry on cherry

**veneer top and chassis finish**  
**3L-W** walnut  
**2KL-W** walnut  
**4L-W** dark mahogany on walnut  
**25M-W** mahogany on walnut  
**25B-W** ebony on walnut  
**25C-W** cherry on walnut  
**2ML-W** natural maple  
**3ML-W** light maple  
**4ML-W** medium maple  
**5ML-W** cherry on maple  
**6LC-W** light cherry on cherry

**7MC-W** medium cherry on cherry  
**8DC-W** dark cherry on cherry  
**9BC-W** burgundy cherry on cherry

**PDFBT2372RCFP-3L-W-A**

unit identification (type), top dimension, chassis option - **chassis & top finish - top material - edge trim**

model number	description	d	w	h	freight	list \$ zone 1	list \$ zone 2
PDM236630RC-EHFP	executive "l" unit	78	66	29	class 125 cwt 525 lb cu ft 640	4,987 W	5,302 W
PDM216630RC-EHFP						4,138 P	4,383 P

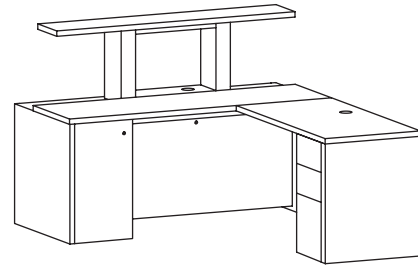

consists of:	d	w	h	quantity
PDD236630LCFP/PDD216630LCFP single pedestal desk left cpu pedestal	30	66	29	1
R2348R-EHFP/R2148R-EHFP single pedestal return right box/box/file pedestal	24	48	29	1

model number	description	d	w	h	freight	list \$ zone 1	list \$ zone 2
PDM236630LC-EHFP	executive "l" unit	78	66	29	class 125 cwt 525 lb cu ft 640	4,987 W	5,302 W
PDM216630LC-EHFP						4,138 P	4,383 P

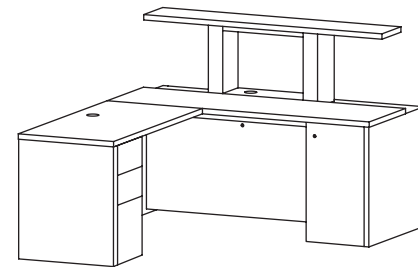

consists of:	d	w	h	quantity
PDD236630RCFP/PDD216630RCFP single pedestal desk right cpu pedestal	30	66	29	1
R2348L-EHFP/R2148L-EHFP single pedestal return left box/box/file pedestal	24	48	29	1

model number	description	d	w	h	freight	list \$ zone 1	list \$ zone 2
PDUMBT2372RC-EHFP	executive bow front "u" unit	110	72	29	class 125 cwt 670 lb cu ft 84	8,133 W	8,696 W
PDUMBT2172RC-EHFP						6,835 P	7,297 P

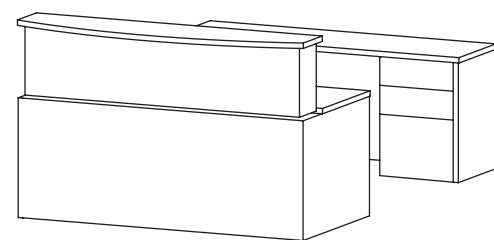

consists of:	d	w	h	quantity
PDDBT2372LCFP/PDDBT2172LCFP bow front single pedestal desk left cpu pedestal	42	72	29	1
B2348-EH/B2148-EH bridge with open kneespace	20	48	29	1
C2372R-FP/C2172R-FP single pedestal credenza right box/box/file pedestal	20	72	29	1

top	P	laminates	bridges
	W	laminates	custom length return and bridge sizes are available up to 65" with the grain direction running lengthwise (opposite the desk grain), add \$410 list and specify length.
edge			



**dlh pointman**

wood top, veneer chassis, veneer drawer fronts  
laminates top, veneer chassis, veneer drawer fronts



model number	description	d	w	h	freight	list \$ zone 1	list \$ zone 2
PDUMBT2372LC-EHFP	executive "u" unit	110	72	29	class 125 cwt 670 lb cu ft 84	8,133 W	8,696 W
PDUMBT2172LC-EHFP						6,835 P	7,297 P

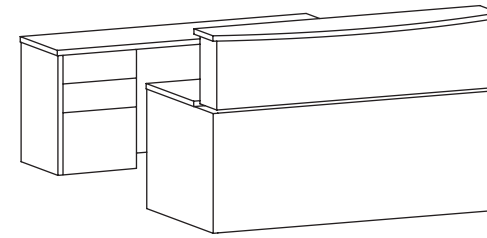

consists of:	d	w	h	quantity
PDDBT2372RCFP/PDDBT2172RCFP bow front single pedestal desk right cpu pedestal	42	72	29	1
B2348-EH/B2148-EH bridge with open kneespace	20	48	29	1
C2372L-FP/C2172L-FP single pedestal credenza left box/box/file pedestal	20	72	29	1

model number	description	d	w	h	freight	list \$ zone 1	list \$ zone 2
PCUMBT2372RC-EHFP	executive "u" unit	110	72	29	class 125 cwt 670 lb cu ft 84	8,133 W	8,696 W
PCUMBT2172RC-EHFP						6,835 P	7,297 P

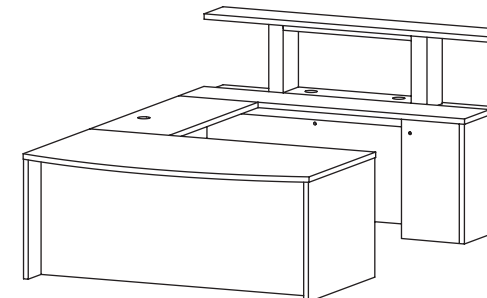

consists of:	d	w	h	quantity
DBT2372L-FP/DBT2172L-FP bow front single pedestal desk left file/file pedestal	42	72	29	1
B2348-EH/B2148-EH bridge with open kneespace	20	48	29	1
PCC2372RCFP/PCC2172RCFP single pedestal credenza right cpu pedestal	20	72	29	1

model number	description	d	w	h	freight	list \$ zone 1	list \$ zone 2
PCUMBT2372LC-EHFP	executive "u" unit	110	72	29	class 125 cwt 670 lb cu ft 84	8,133 W	8,696 W
PCUMBT2172LC-EHFP						6,835 P	7,297 P

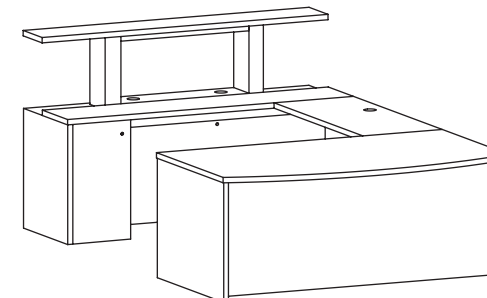

consists of:	d	w	h	quantity
DBT2372R-FP/DBT2172R-FP bow front single pedestal desk right file/file pedestal	42	72	29	1
B2348-EH/B2148-EH bridge with open kneespace	20	48	29	1
PCC2372LCFP/PCC2172LCFP single pedestal credenza left cpu pedestal	20	72	29	1

laminates tops only	3L-P	walnut	veneers top and chassis finish	3L-W	walnut	7MC-W	medium cherry on cherry
	4L-P	dark mahogany on walnut		4L-W	walnut	8DC-W	dark cherry on cherry
	25M-P	mahogany on walnut		4L-W	dark mahogany on walnut	9BC-W	burgundy cherry on cherry
	25C-P	cherry on walnut		25M-W	mahogany on walnut		
	25B-P	ebony on walnut		25B-W	ebony on walnut		
	2ML-P	natural maple		25C-W	cherry on walnut		
	3ML-P	light maple		2ML-W	natural maple		
	4ML-P	medium maple		3ML-W	light maple		
	5ML-P	cherry on maple		4ML-W	medium maple		
	6LC-P	light cherry on cherry		5ML-W	cherry on maple		
	7MC-P	medium cherry on cherry		6LC-W	light cherry on cherry		
	8DC-P	dark cherry on cherry					

**PDFBT2372RCFP-3L-W-A**

unit identification (type), top dimension, chassis option - **chassis & top finish - top material - edge trim**

model number	description	d	w	h	freight	list \$ zone 1	list \$ zone 2
PDUM2372RC-EHFP- - - - PDUM2172RC-EHFP- - - -	executive "u" unit	104	72	29	class 125 cwt 680 lb cu ft 82	6,735 W 5,557 P	7,186 W 5,916 P

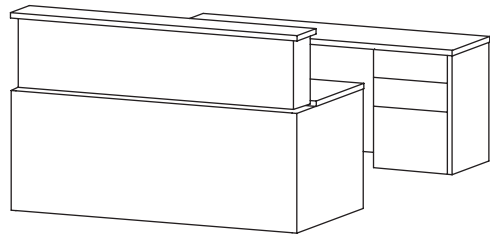

consists of:	d	w	h	quantity
PDD2372LCFP/PDD2172LCFP single pedestal desk left cpu pedestal	36	72	29	1
B2348-EH/B2148-EH bridge with open kneespace	20	48	29	1
C2372R-FP/C2172R-FP single pedestal credenza right box/box/file pedestal	20	72	29	1

model number	description	d	w	h	freight	list \$ zone 1	list \$ zone 2
PDUM2372LC-EHFP- - - - PDUM2172LC-EHFP- - - -	executive "u" unit	104	72	29	class 125 cwt 680 lb cu ft 82	6,735 W 5,557 P	7,186 W 5,916 P

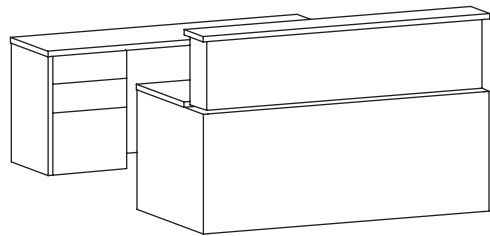

consists of:	d	w	h	quantity
PDD2372RCFP/PDD2172RCFP single pedestal desk right cpu pedestal	36	72	29	1
B2348-EH/B2148-EH bridge with open kneespace	20	48	29	1
C2372L-FP/C2172L-FP single pedestal credenza left box/box/file pedestal	20	72	29	1

model number	description	d	w	h	freight	list \$ zone 1	list \$ zone 2
PCUM2372RC-EHFP- - - - PCUM2172RC-EHFP- - - -	executive "u" unit	104	72	29	class 125 cwt 680 lb cu ft 82	6,735 W 5,557 P	7,186 W 5,916 P

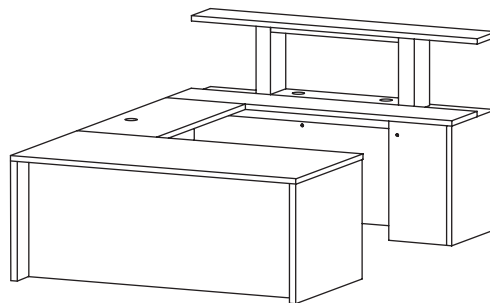

consists of:	d	w	h	quantity
D2372L-FP/D2172L-FP single pedestal desk left file/file pedestal	36	72	29	1
B2348-EH/B2148-EH bridge with open kneespace	20	48	29	1
PCC2372RCFP/PCC2172RCFP single pedestal credenza right cpu pedestal	20	72	29	1

top	P	W	bridges
	laminates top	veneers top	custom length bridge sizes are available up to 65" with the grain direction running lengthwise (opposite the desk grain), add \$410 list and specify length.
edge			

**dlh pointman**

wood top, veneer chassis, veneer drawer fronts  
laminates top, veneer chassis, veneer drawer fronts



model number	description	d	w	h	freight	list \$ zone 1	list \$ zone 2
PCUM2372LC-EHFP- - - - PCUM2172LC-EHFP- - - -	executive "u" unit	104	72	29	class 125 cwt 680 lb cu ft 82	6,735 W 5,557 P	7,186 W 5,916 P

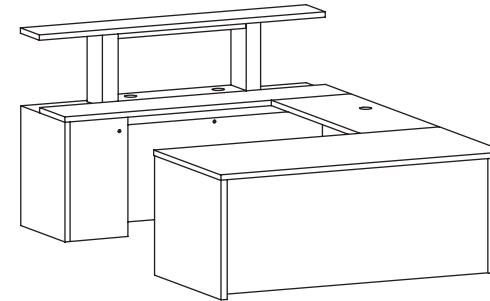

consists of:	d	w	h	quantity
D2372R-FP/D2172R-FP single pedestal desk right file/file pedestal	36	72	29	1
B2348-EH/B2148-EH bridge with open kneespace	20	48	29	1
PCC2372LCFP/PCC2172LCFP single pedestal credenza left cpu pedestal	20	72	29	1

model number	description	d	w	h	freight	list \$ zone 1	list \$ zone 2
PDUM2366RC-EHFP- - - - PDUM2166RC-EHFP- - - -	executive "u" unit	104	66	29	class 125 cwt 670 lb cu ft 77	6,424 W 5,380 P	6,851 W 5,726 P

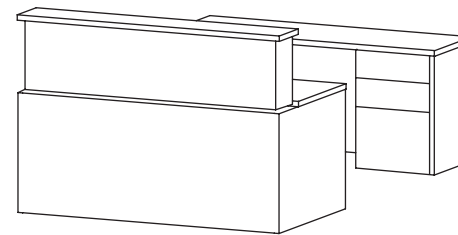

consists of:	d	w	h	quantity
PDD2366LCFP/PDD2166LCFP single pedestal desk left cpu pedestal	36	66	29	1
B2348-EH/B2148-EH bridge with open kneespace	20	48	29	1
C2366R-FP/C2166R-FP single pedestal credenza right box/box/file pedestal	20	66	29	1

model number	description	d	w	h	freight	list \$ zone 1	list \$ zone 2
PDUM2366LC-EHFP- - - - PDUM2166LC-EHFP- - - -	executive "u" unit	104	66	29	class 125 cwt 670 lb cu ft 77	6,424 W 5,380 P	6,851 W 5,726 P

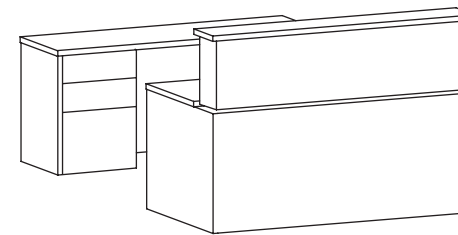

consists of:	d	w	h	quantity
PDD2366RCFP/PDD2166RCFP single pedestal desk right cpu pedestal	36	66	29	1
B2348-EH/B2148-EH bridge with open kneespace	20	48	29	1
C2366L-FP/C2166L-FP single pedestal credenza left box/box/file pedestal	20	66	29	1

laminates tops only	3L-P	4L-P	25M-P	25B-P	2ML-P	3ML-P	4ML-P	5ML-P	6LC-P	7MC-P	8DC-P	veneers top and chassis finish	3L-W	2KL-W	4L-W	25M-W	25B-W	25C-W	2ML-W	3ML-W	4ML-W	5ML-W	6LC-W	7MC-W	8DC-W	9BC-W
	walnut	dark mahogany on walnut	mahogany on walnut	cherry on walnut	ebony on walnut	natural maple	light maple	medium maple	cherry on maple	light cherry on cherry	medium cherry on cherry	dark cherry on cherry	walnut	walnut	dark mahogany on walnut	mahogany on walnut	ebony on walnut	cherry on walnut	natural maple	light maple	medium maple	cherry on maple	light cherry on cherry	medium cherry on cherry	dark cherry on cherry	burgundy cherry on cherry

PDFBT2372RCFP-3L-W-A

unit identification (type), top dimension, chassis option - **chassis & top finish - top material - edge trim**

dlh pointman

wood top, veneer chassis, veneer drawer fronts  
laminate top, veneer chassis, veneer drawer fronts



model number	description	d	w	h	freight	list \$ zone 1	list \$ zone 2
PCUM2366RC-EHFP- - - - - PCUM2166RC-EHFP- - - - -	executive "u" unit	104	66	29	class 125 cwt 670 lb cu ft 77	6,424 W 5,380 P	6,851 W 5,726 P

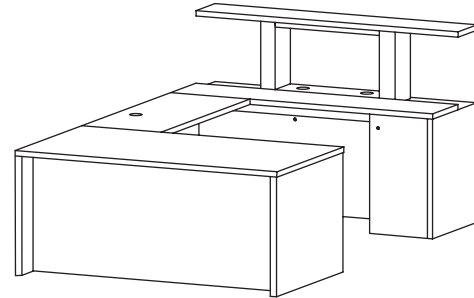

consists of:	d	w	h	quantity
D2366L-FP/D2166L-FP single pedestal desk left file/file pedestal	36	66	29	1
B2348-EH/B2148-EH bridge with open kneespace	20	48	29	1
PCC2366RCFP/PCC2166RCFP single pedestal credenza right cpu pedestal	24	66	29	1

model number	description	d	w	h	freight	list \$ zone 1	list \$ zone 2
PDUM236630LC-EHFP- - - - - PDUM216630LC-EHFP- - - - -	executive "u" unit	98	66	29	class 125 cwt 660 lb cu ft 69	6,298 W 5,014 P	6,718 W 5,330 P

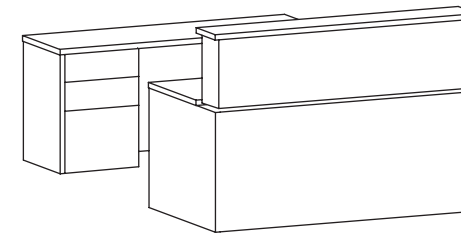

consists of:	d	w	h	quantity
PDD236630RCFP/PDD216630RCFP single pedestal desk right cpu pedestal	30	66	29	1
B2348-EH/B2148-EH bridge with open kneespace	20	48	29	1
C2366L-FP/C2166L-FP single pedestal credenza left box/box/file pedestal	20	66	29	1

model number	description	d	w	h	freight	list \$ zone 1	list \$ zone 2
PCUM2366LC-EHFP- - - - - PCUM2166LC-EHFP- - - - -	executive "u" unit	104	66	29	class 125 cwt 670 lb cu ft 77	6,424 W 5,380 P	6,851 W 5,726 P

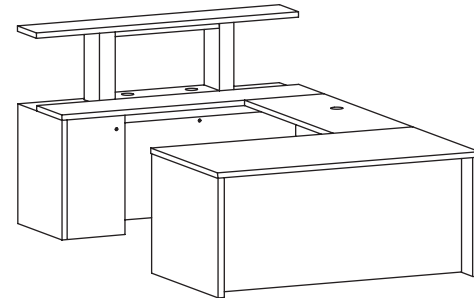

consists of:	d	w	h	quantity
D2366R-FP/D2166R-FP single pedestal desk right file/file pedestal	36	66	29	1
B2348-EH/B2148-EH bridge with open kneespace	20	48	29	1
PCC2366LCFP/PCC2166LCFP single pedestal credenza left cpu pedestal	24	66	29	1

model number	description	d	w	h	freight	list \$ zone 1	list \$ zone 2
PCUM236630RC-EHFP- - - - - PCUM216630RC-EHFP- - - - -	executive "u" unit	98	66	29	class 125 cwt 660 lb cu ft 77	6,298 W 5,014 P	6,718 W 5,330 P

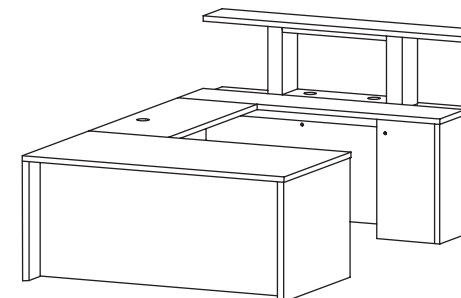

consists of:	d	w	h	quantity
D236630L-FP/D216630L-FP single pedestal desk left file/file pedestal	30	66	29	1
B2348-EH/B2148-EH bridge with open kneespace	20	48	29	1
PCC2366RCFP/PCC2166RCFP single pedestal credenza right cpu pedestal	20	66	29	1

model number	description	d	w	h	freight	list \$ zone 1	list \$ zone 2
PDUM236630RC-EHFP- - - - - PDUM216630RC-EHFP- - - - -	executive "u" unit	98	66	29	class 125 cwt 660 lb cu ft 69	6,298 W 5,014 P	6,718 W 5,330 P

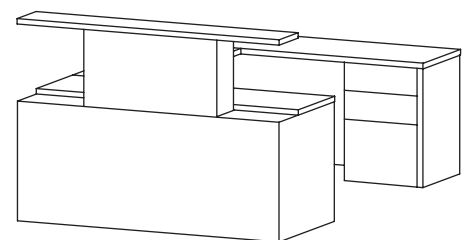

consists of:	d	w	h	quantity
PDD236630RCFP/PDD216630RCFP single pedestal desk left cpu pedestal	30	66	29	1
B2348-EH/B2148-EH bridge with open kneespace	20	48	29	1
C2366R-FP/C2166R-FP single pedestal credenza right box/box/file pedestal	20	66	29	1

model number	description	d	w	h	freight	list \$ zone 1	list \$ zone 2
PCUM236630LC-EHFP- - - - - PCUM216630LC-EHFP- - - - -	executive "u" unit	98	66	29	class 125 cwt 660 lb cu ft 77	6,298 W 5,014 P	6,718 W 5,330 P

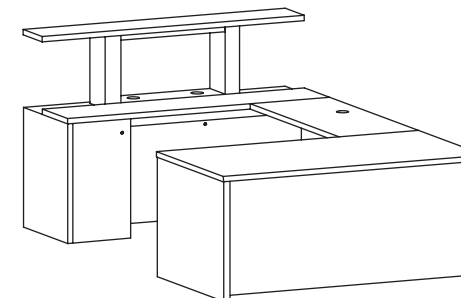

consists of:	d	w	h	quantity
D236630R-FP/D216630R-FP single pedestal desk right file/file pedestal	30	66	29	1
B2348-EH/B2148-EH bridge with open kneespace	20	48	29	1
PCC2366LCFP/PCC2166LCFP single pedestal credenza left cpu pedestal	20	66	29	1

**top** P laminate top  
W veneer top

**bridges** custom length bridge sizes are available up to 65" with the grain direction running lengthwise (opposite the desk grain), add \$410 list and specify length.

**edge**



**laminate tops only**

3L-P walnut  
4L-P dark mahogany on walnut  
25M-P mahogany on walnut  
25C-P cherry on walnut  
25B-P ebony on walnut  
2ML-P natural maple  
3ML-P light maple  
4ML-P medium maple  
5ML-P cherry on maple  
6LC-P light cherry on cherry  
7MC-P medium cherry on cherry  
8DC-P dark cherry on cherry

**veneer top and chassis finish**

3L-W walnut  
2KL-W walnut  
4L-W dark mahogany on walnut  
25M-W mahogany on walnut  
25B-W ebony on walnut  
25C-W cherry on walnut  
2ML-W natural maple  
3ML-W light maple  
4ML-W medium maple  
5ML-W cherry on maple  
6LC-W light cherry on cherry

7MC-W medium cherry on cherry  
8DC-W dark cherry on cherry  
9BC-W burgundy cherry on cherry